

SR-730 PG2

Fully Wireless PowerG Outdoor Siren



A Tyco International Company

Installation Instructions

1. INTRODUCTION

The SR-730 PG2 is a fully wireless outdoor siren, designed for installation in areas in which wiring action is difficult or impossible.

The siren is compatible with PowerG control panels.

Features

- **Siren and strobe light activation:** When an identified event message is received from the compatible PowerG alarm system, the siren activates its sounder & strobe light.

Notes: *The sounder is activated for a predefined "Bell Time" (refer to the control panel Installer Guide), according to local authorities requirements, or until the system is disarmed, whichever occurs first.*

The strobe light operates as described in the PowerG Installer Guide.

- **Tamper indication:** In case of tamper while the system is armed, the siren transmits the message to the alarm system and then the alarm system determines whether the siren should be activated or not. If the siren does not receive an acknowledge message from the alarm system, the siren will function independently.
- **Low battery voltage alert:** When the battery voltage is low, a low battery message is sent to the alarm system. After the low voltage message delivery, at least 2 siren alarms are possible before the siren is totally inactive.
- **Power Supply Options:** Non-rechargeable battery. Optional - two non-rechargeable batteries.
- **Sound Types:** Burglar (between 1400Hz - 3200Hz), fire, gas/Co and flood.
- **Entry/Exit:** Exit delay beeps sound once the user has armed the system. Entry delay beeps sound once the user has entered the protected area. (Entry/exit beeps can be enabled / disabled from the control panel Installer menu.)
- **Squawk indications:** Squawk (beep) sounds can be used to indicate alarm system arming (1 squawk) and disarming (2 squawks) by a keyfob (squawk can be enabled from the control panel User menu).

- **Strobe Light Color:** The siren can be purchased with red, blue, amber or transparent lens, according to the desired strobe light color.

- **Siren activity LED:** A flashing LED (optional, at the bottom of the siren front panel) indicates siren activity (can be disabled by the control panel)

- **Double Tamper protection:** When the siren front panel is removed or when the siren is removed from the wall, tamper alarm is sent to the alarm system.

IMPORTANT! The SR-730 PG2 siren must be installed on the wall in a vertical position with the screw pointing to the floor only, as illustrated in Figure 1b. The importance of correct positioning of the SR-730 PG2 is to enable the siren to function as a waterproof device.

- **2-way full supervision**

The siren is fully supervised, 2-way communication device. It includes a receiver, to receive event messages from the alarm system, and a transmitter, to periodically transmit its status signal to the alarm system.

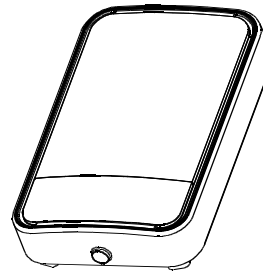
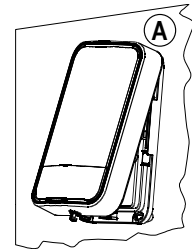

Fig. 1a - External View



A. Wall

Fig. 1b - Mounting Position

Self-test feature

Upon pressing the self test switch, siren functional check is performed - low level sounds and flash light indicate that the siren is serviceable.

2. INSTALLATION

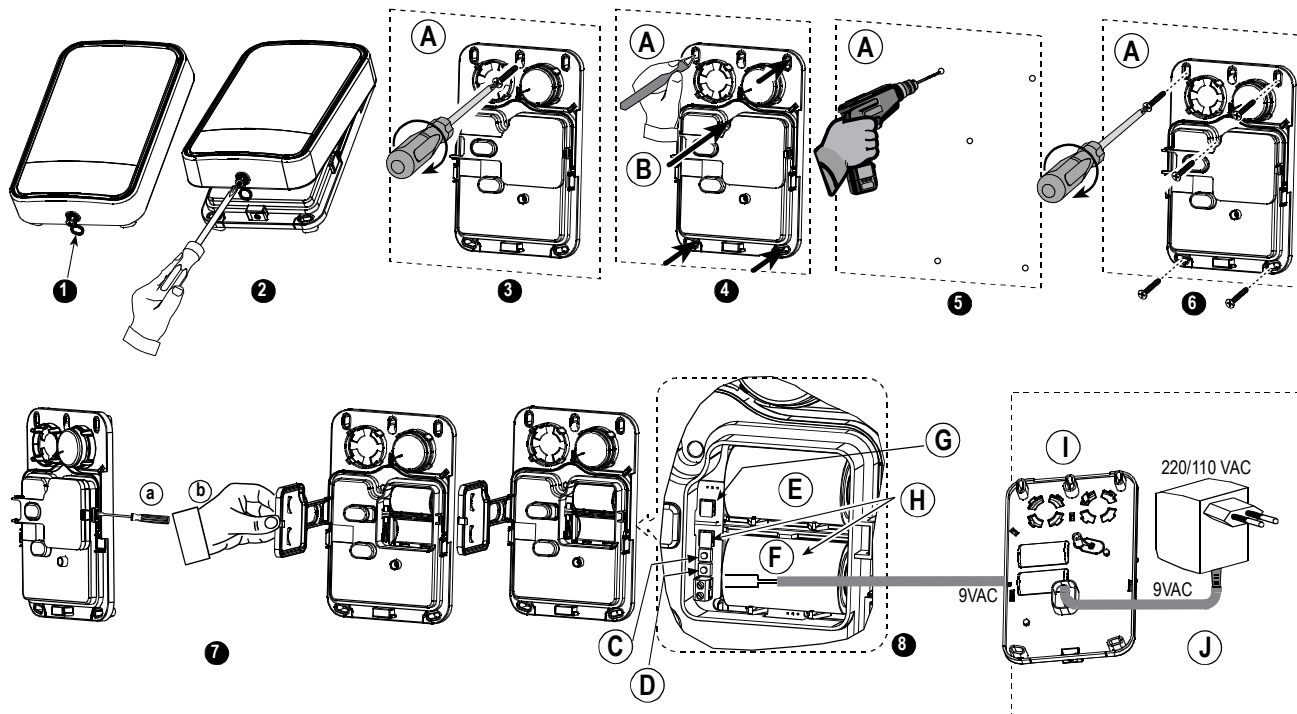

1. Open plastic cover screw.
 2. Using Philips screwdriver, remove screw and remove cover.
 3. Optional step: Hang back unit with a screw on mounting surface to make the next step (drilling marking) easier.
 4. Mark for drilling.
 5. Drill 5 holes.
 6. Fasten with 5 screws.
 7. Release catch (A) and open battery cover (B).
 8. Connect battery / optional battery and 9VAC power to the proper connectors and set the optional jumpers as desired.
- A.** Mounting surface.
B. For tamper.
C. Self-Test button.
D. Enroll button.
E. Primary battery.
F. Secondary battery.
G. Battery connector.
H. Optional second battery and its connector.
I. Siren rear side.
J. When external power is used, set the AC Enable (ON) / Disable (OFF) jumper to Enable position (see step 8).
- Note:** There are SR-730 PG2 model variations that are supplied with battery only, or, with battery and AC adaptor.

Figure 2: Installation

WARNING: To comply with FCC and IC RF exposure compliance requirements, the siren should be located in a distance of at least 20 cm from all persons during normal operation. The antennas used for this product must not be co-located or operated in conjunction with any other antenna or transmitter

CAUTION! Risk of explosion if battery is replaced by an incorrect type. Dispose of used battery according to manufacturer's instructions..

3. ENROLLMENT

Refer to the control panel Installer Guide for the device enrollment procedure.

4. SR-730 PG2 DEVICE SETTINGS

This section describes how to configure the parameters of the siren from the control panel.

To Modify the Siren Device Settings

Refer to the control panel Installer Guide and perform the procedure for Adding A Wireless Device (section 4.5.2), or, Modifying a Device (section 4.5.5). Then continue below to modify the device settings.



DEV SETTINGS





1. OK



STROBE ALARM

Here you determine whether or not to activate the strobe alarm, and if to activate whether to activate the strobe until the alarm system is disarmed, or, for the programmed period of



time (see section "Siren Configuration" in the control panel Installer Guide).





2. 



Timer limited
3.  or 
Select between "Timer limited", "Disabled" and "Until Disarmed".
4. 

STROBE ALARM
5. 



EXIT-ENTRY Beeps





Here you determine whether or not to activate the exit – entry beeps, and if enabled, whether to activate in HOME or AWAY mode.
6. 



Disabled
7.  or 
Select between "Disabled", "Disabled _ Home" and "Enabled".
8. 

EXIT-ENTRY Beeps
9. 



SQUAWK





Here you determine whether or not to activate the squawk, and if enabled, whether to activate the sounder only, the strobe only, or the sounder and strobe simultaneously.
10. 



Disabled
11.  or 
Select between "Disabled", "Sounder only", "Strobe only" and "Sounder+strobe".
12. 

SQUAWK
13. 



SOUNDER VOLUME





Here you determine the volume level of the sounder.
14. 



Volume HIGH
15.  or 
Select between "Volume HIGH", "Volume LOW" and "Volume MID".
16. 

SOUNDER VOLUME
17. 



ACTIVITY LED





Here you determine whether or not the LED will be activated to indicate that the siren is operating.
18. 

Disabled
19.  or 
Select between "Disabled", and "Enabled".
20. 

ACTIVITY LED
21. 

AUTO TAMPER ALRM

Here you determine whether or not the siren alone will sound a tamper alarm when there is no communication between the siren and the control panel.
22. 

Disabled
23.  or 
Select between "Disabled" and "Enabled".
24. 

AUTO TAMPER ALRM

When exiting "INSTALLER MODE" menu, the alarm system displays the number of devices that need to be updated, as follows: "DEV UPDATING NNN".

For detailed instructions on Adding Devices, Deleting Devices, Replacing Devices and Defining Defaults see the control panel Installer Guide.

5. LOCAL DIAGNOSTICS TEST

Before testing, remove the plastic cover and then open the battery cover (see Fig. 2).

A. Press the self-test button once and release it; the following procedure should occur in turn:

The red LED will switch ON and then OFF, the green LED will switch ON and then OFF, the strobe light will switch ON and then OFF and the piezo siren will sound to indicate that the siren is now fully operational.

B. After 2 seconds the LED blinks 3 times.

The following table indicates received signal strength indication.

LED response	Reception
Green LED blinks	Strong
Orange LED blinks	Good
Red LED blinks	Poor
No blinks	No communication

IMPORTANT! Reliable reception must be assured. Therefore, "poor" signal strength is not acceptable. If you receive a "poor" signal from the device, re-locate it and re-test until a "good" or "strong" signal strength is received.

Note: For detailed Diagnostics Test instructions refer to the control panel Installer Guide.

6. COMPLIANCE WITH STANDARDS

Compliance with Standards



Europe: EN50131-1 Grade 2 Class 4, EN 50131-4, EN 50131-6, EN 301489, EN 50130-4, EN 50130-5, EN 300 220, EN 60950-1, EN 60950-22 Environmental IP55.

The SR-730 PG2 is compatible with the RTTE requirements - Directive 1999/5/EC of the European Parliament and of the Council of 9 March 1999 and EN50131-1 Grade 2 Class II.

Certified by the Dutch testing and certification body *Telefication BV*.

USA: CFR 47 Part 15 (FCC)

Canada: RSS 210

The Power G peripheral devices have two-way communication functionality, providing additional benefits as described in the technical brochure. This functionality has not been tested to comply with the respective technical requirements and should therefore be considered outside the scope of the product's certification.

EN 50131-1 Security Grade

Grade 2

EN 50131-1 Environmental Class

Class 4

FCC Compliance Statement

The digital circuit of this device has been tested and found to comply with the limits for a Class B digital device, pursuant to Part 15 of the FCC Rules. These limits are designed to provide reasonable protection against harmful interference in residential installations. This equipment generates, uses and can radiate radio frequency energy and, if not installed and used in accordance with the instructions, may cause harmful interference to radio and television reception. However, there is no guarantee that interference will not occur in a particular installation. If this device does cause such interference, which can be verified by turning the device off and on, the user is encouraged to eliminate the interference by one or more of the following measures:

- Re-orient or re-locate the receiving antenna.
- Increase the distance between the device and the receiver.
- Connect the device to an outlet on a circuit different from the one which supplies power to the receiver.
- Consult the dealer or an experienced radio/TV technician.

This device complies with FCC Rules Part 15 and with Industry Canada licence-exempt RSS standard(s). Operation is subject to two conditions: (1) This device may not cause harmful interference, and (2) this device must accept any interference that may be received or that may cause undesired operation.

Le présent appareil est conforme aux CNR d'Industrie Canada applicables aux appareils radio exempts de licence. L'exploitation est autorisée aux deux conditions suivantes : (1) l'appareil ne doit pas produire de brouillage, et (2) l'utilisateur de l'appareil doit accepter tout brouillage radioélectrique subi, même si le brouillage est susceptible d'en compromettre le fonctionnement.

WARNING! Changes or modifications to this unit not expressly approved by the party responsible for compliance could void the user's authority to operate the equipment.

The technical documentation as required by the European Conformity Assessment procedure is kept at:

UNIT 6 MADINGLEY COURT CHIPPENHAM DRIVE KINGSTON MILTON KEYNES MK10 0BZ. TEL.: +44(0)845 0755800 FAX: +44(0)845 0755801



W.E.E.E. Product Recycling Declaration

For information regarding the recycling of this product you must contact the company from which you originally purchased it. If you are discarding this product and not returning it for repair then you must ensure that it is returned as identified by your supplier. This product is not to be thrown away with everyday waste.
Directive 2002/96/EC Waste Electrical and Electronic Equipment.

7. SPECIFICATIONS

Frequency Band (MHz): Europe: 433, 868, USA: 915

Modulation: GFSK

Antenna: Built-in antenna

Communication Protocol: PowerG

Siren Type: One Piezo 109 db min. Sound Pressure Level @ 1m, 1.4-3.2 kHz, sweep frequency 7 Hz. Additional piezo is optional.

Power Supply: Type C

Battery Type: 3.6V/14.5A/H Lithium battery (EVE ER34615M/w200), Visonic assembly cat. No. 0-9912-K.

Note: Use only the above battery.

Note: The strobe flashes 5 times and the red LED lights continuously during first battery installation.

Battery Life Expectancy: 8 years (for typical use)

Low Battery Threshold: 2 V +300 mV negative slope OR 1.2 V

Strobe Light: Pulsed @ 1 sec.

Operating Temperature: -33°C to 70°C (-27.4°F to 158°F), RH humidity 75%.

Dimensions (LxWxD): 295x186x63mm (11-5/8 x 7-5/16 x 2-1/2 in)

Weight (including battery): 970g (34 oz)

Color: White (with red, blue, amber or transparent lens)



A Tyco International Company

VISIONIC LTD. (ISRAEL): P.O.B 22020 TEL-AVIV 61220 ISRAEL. PHONE: (972-3) 645-6789, FAX: (972-3) 645-6788

VISIONIC INC. (U.S.A.): 65 WEST DUDLEY TOWN ROAD, BLOOMFIELD CT. 06002-1376. PHONE: (860) 243-0833, (800) 223-0020.

FAX: (860) 242-8094

VISIONIC LTD. (UK): UNIT 6 MADINGLEY COURT CHIPPENHAM DRIVE KINGSTON MILTON KEYNES MK10 0BZ. TEL.: +44(0)845 0755800

FAX: +44(0)845 0755801 PRODUCT SUPPORT: +44(0)845 755802

VISIONIC GmbH (D-A-CH): KIRCHFELDDSTR. 118, D-40215 DÜSSELDORF. TEL.: +49 (0)211 600696-0, FAX: +49 (0)211 600696-19

VISIONIC IBERICA: ISLA DE PALMA, 32 NAVE 7, POLIGONO INDUSTRIAL NORTE, 28700 SAN SEBASTIÁN DE LOS REYES, (MADRID), ESPAÑA.

TEL (34) 91659-3120, FAX (34) 91663-8468. www.visonic-iberica.es INTERNET: www.visonic.com

©VISIONIC LTD. 2012 D-302414 SR-730 PG2 (REV. 2, 02/12)